

LEPT

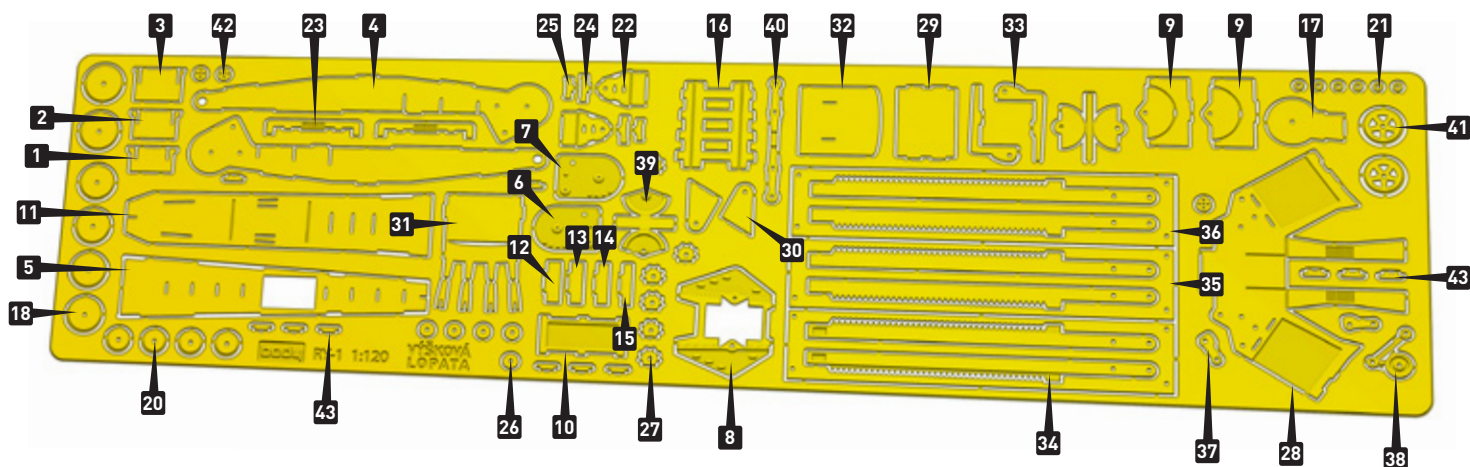

LETUJTE

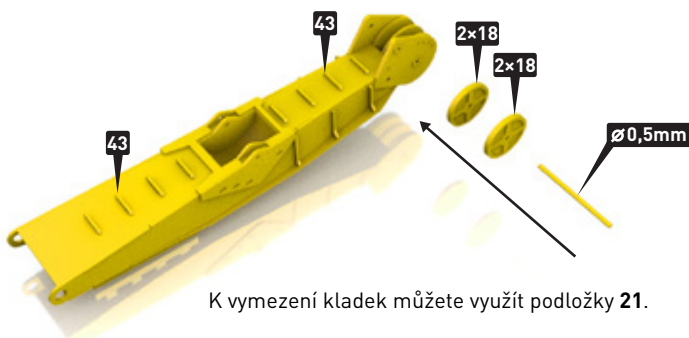
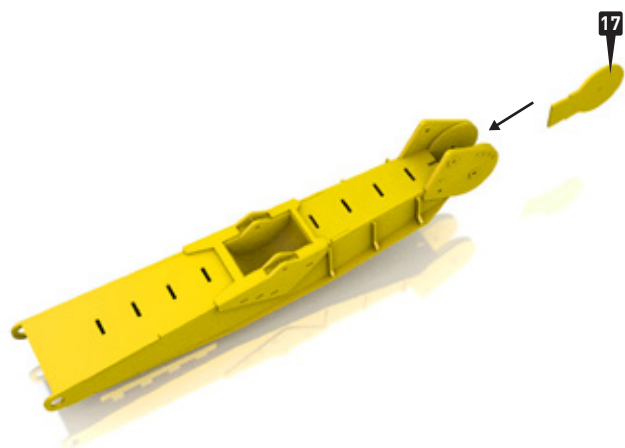
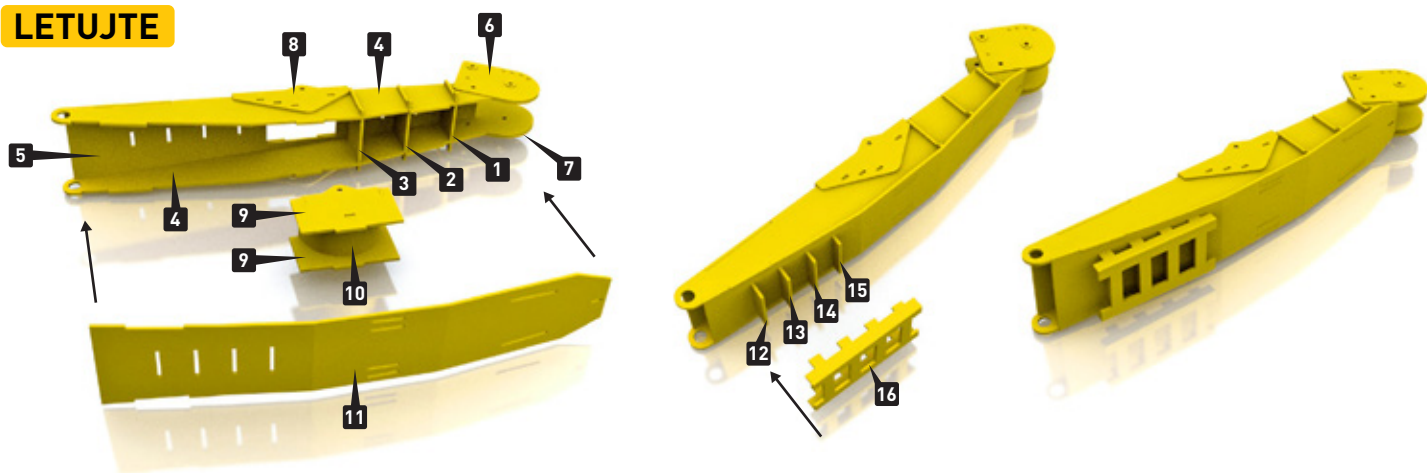

K vymezení kladek můžete využít podložky 21.

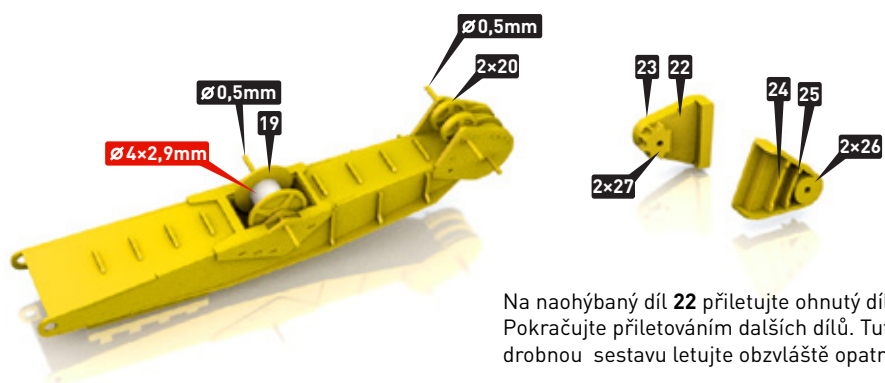

Na naohýbaný díl 22 přilepte ohnutý díl 23. Pokračujte přiletováním dalších dílů. Tuto drobnou sestavu letejte obzvláště opatrně.

Na mosaznou trubičku daných rozměrů (červeně) naletujte dílky 19. Buben poté pomocí drátku průměru 0,5 mm vletujte do výložníku.



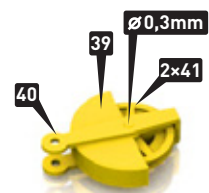
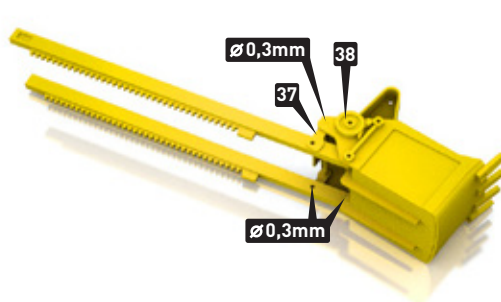
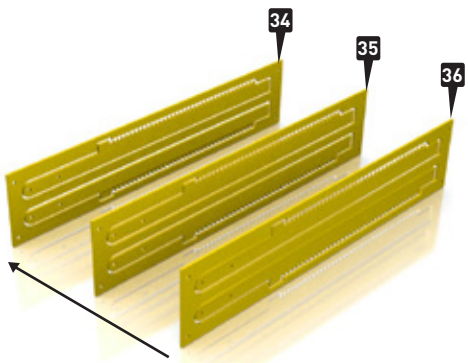
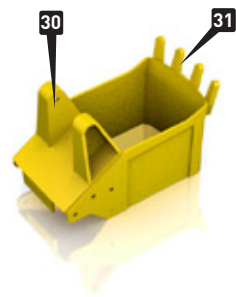
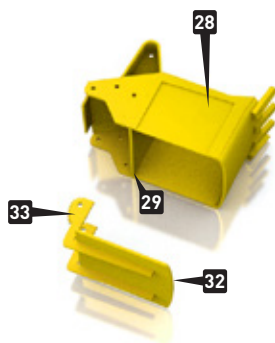
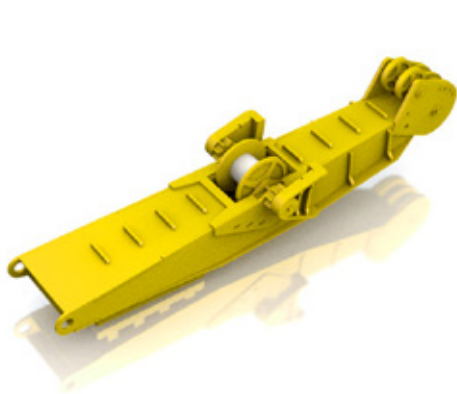

Díly slícujte a proleťte.

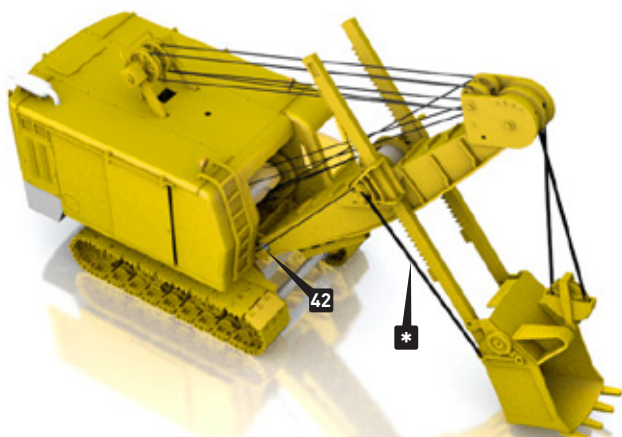

* Lano otevírání lopaty

Detailnější schéma natažení lan na následující stránce.

* Zde je lano  přivázáno k hřídeli kladek.

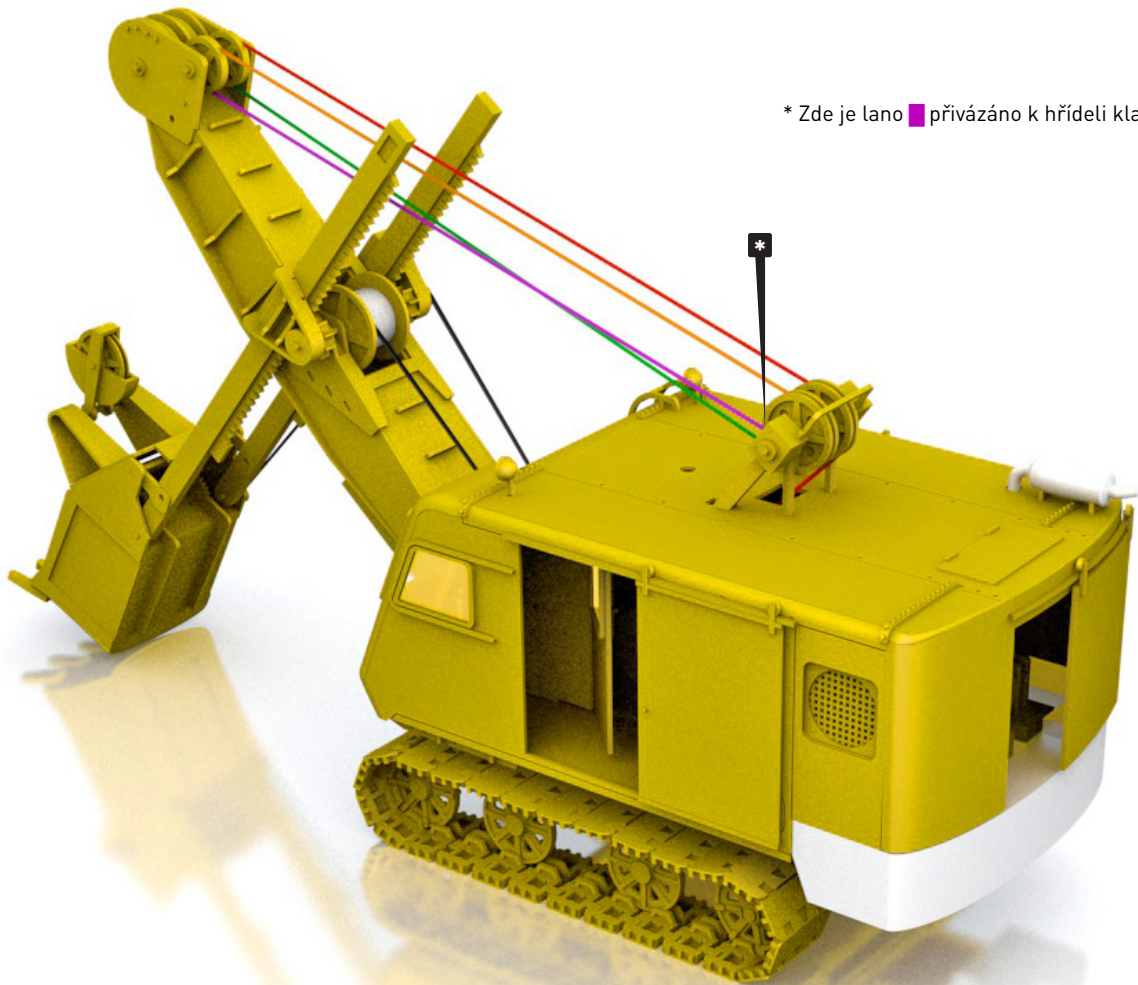

Lano zvedání výložníku vede ze strojovny v tomto pořadí: 